

SODIUM CHLORITE HANDBOOK

Technical Information

NOVEMBER 2023

OxyChem[®]

Dallas-based Occidental Chemical Corporation is a leading North American manufacturer of basic chemicals, vinyls, and performance chemicals directly and through various affiliates (collectively, OxyChem). OxyChem is also America's only producer of sodium chlorite.

Occidental Chemical Corporation

Basic Chemicals Group

14555 Dallas Parkway, Suite 400

Dallas, TX 75254

800-752-5151

As a Responsible Care® company, OxyChem's global commitment to safety and the environment goes well beyond compliance. OxyChem's Health, Environment, and Safety philosophy is a positive motivational force for our employees and helps create a strong culture for protecting human health and the environment. Our risk management programs, and methods have been, and continue to be, recognized as some of the industry's best.

OxyChem offers an effective combination of industry expertise, experience, online business tools, quality products and exceptional customer service. As a member of the Occidental Petroleum Corporation family, OxyChem represents a rich history of experience, top-notch business acumen, and sound, ethical business practices.

Contents

Introduction to Sodium	5
Manufacturing	5
Sodium Chlorite End Uses	5
Sodium Chlorite Product Grades	6
Safety and Handling	7
Toxicological Properties	7
Personnel Protection	8
First Aid	8
Storage and Handling	9
Spill and Leak Procedures	9
Disposal	9
Regulatory Information	10
EPA Registration	10
Food and Drug Administration (FDA)	10
United States Department of Agriculture (USDA)	10
Clean Air Act	11
Federal Water Pollution Control Act (Clean Water Act)	11
Resource Conservation and Recovery Act (RCRA)	12
Handling and Storage	13
Materials Of Compatibility	13
Unloading Sodium Chlorite Tank Trucks	15
Unloading Sodium Chlorite Tank Cars	18
Unloading Procedures for Tank Cars	19

Unloading with Compressed Air..... 19

Unloading By Pump 22

Preparing Empty Tank Cars for Return..... 23

Technical Data 25

 Preparing a 25% sodium chlorite solution from OxyChem Technical Sodium Chlorite (dry) product. 25

 Sodium Chlorite Solutioning Instructions: 25

Methods of Analysis 27

 Determination of Sodium Chlorite Strength in Sodium Chlorite Products 27

 Determination of Sodium Hydroxide and Sodium Carbonate in Sodium Chlorite Products 29

 Determination of Hydrogen Peroxide in Sodium Chlorite Products 30

 Determination of Sodium Chlorate and Sodium Sulfate in Sodium Chlorite by Ion Chromatorgraphy with
 Conductivity Detection 31

INTRODUCTION TO SODIUM

MANUFACTURING

Sodium chlorite is made by the partial reduction of sodium chlorate to chlorine dioxide and the chlorine dioxide's subsequent conversion to sodium chlorite in an alkaline solution in the presence of hydrogen peroxide. An excess of both peroxide and caustic is present to ensure complete reaction as follows:

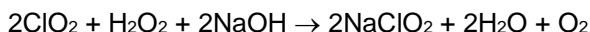

Under these conditions, ClO_2 is also known to disproportionate to chlorite and chlorate as follows:



Any chlorine present would be in the hypochlorite form because of the strong alkaline conditions. Hypochlorite will react with hydrogen peroxide to yield chloride as follows:

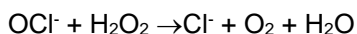

Because there is no source of ammonia or nitrogen in the process, chloramines will not be present as an impurity.

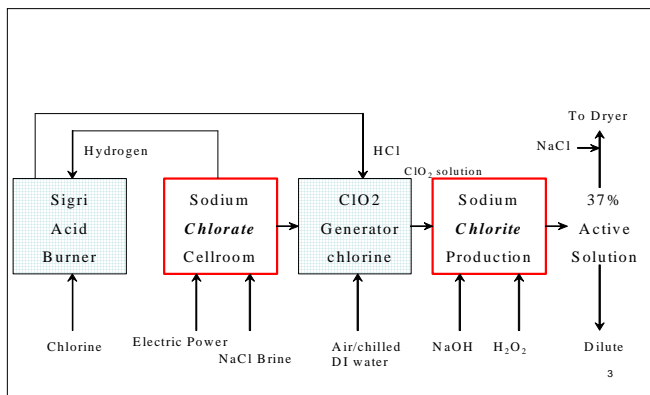

Sodium Chlorite Process

SODIUM CHLORITE END USES

Sodium Chlorite Applications

Hydrogen Sulfide Odor Control: In the ionic form, sodium chlorite is almost exclusively reactive to hydrogen sulfide, and does not react with ammonia or form other chlorinated compounds.

Copper Cyanide Destruction: Copper Cyanide, which is formed in the recovery process for copper metal, is the only cyanide that catalyzes sodium chlorite making it an effective option.

Absorption/Oxidation: Sodium chlorite followed by reduction with sodium sulfide is a NO_x and Sox control technology. This method is applicable to all forms of NO_x from combustion, nitration, and metal finishing sources.

Bleaching Textiles: Sodium chlorite will bleach thread, yarns, and fabrics to a high white without loss of strength. This method provides a good foundation for re-dyeing with different colors.

Chlorine Dioxide Applications

Chlorine dioxide has a variety of commercial uses. In all of the following applications, sodium chlorite is used in the generation of the chlorine dioxide.

Treatment of Potable Water: Chlorine dioxide has long been used to remove tastes and odors in potable water. It is also used in the disinfection of water, particularly where trihalomethanes are of concern. Chlorine dioxide also oxidizes soluble manganese and iron compounds, eliminating a major cause of stained sinks and fixtures.

Bacterial Control in Oil Wells and Petroleum Systems: A patented use for chlorine dioxide is to treat water that is or will be contaminated with petroleum oil. Many such mixtures contain sulfite-reducing bacteria that form undesirable sulfide compounds. Chlorine dioxide oxidizes these sulfides to sulfates, while preventing or substantially retarding the formation of colloidal sulfur.

Biofuels Bacterial Control: Used as a processing aid in alcohol and fuel ethanol production with distillers' grains approved for use in animal feed (cattle, poultry, swine). Controls lactic and acetic acid producing bacterial contamination. Suitable for ethanol production from sugar and grain.

Bacterial Slime Control in Paper Mills: Some of the major operational problems in paper and paperboard production are caused by proliferation of microbiological organisms in white water and stock systems. As an oxidizing biocide, chlorine dioxide, can control microbiological growths, which cause paper malodors and discoloration, deterioration of felts, equipment corrosion, fouling of pipes and showers, and paper quality problems such as spots, specks, and holes.

Food Processing: Chlorine Dioxide is highly effective for microbiological control in organically contaminated flume waters. Control of microbiological growths is necessary to ensure food product safety and quality. Chlorine dioxide has also found an application in cherry bleaching.

Algae Control in Cooling Towers: Chlorine dioxide efficiently and economically controls microbiological growths in industrial cooling waters under conditions unfavorable to chlorine. It is the primary microbiological control agent in systems with high pH, ammonia-nitrogen contamination, or persistent slime problems.

Treatment of Wastes: Chlorine dioxide is used to disinfect sewage and plant wastes. It destroys phenolics, simple cyanides and sulfides by oxidation.

Stripping Dyestuffs from Textiles: Chlorine dioxide removes dyestuffs from textiles with a minimum of fiber degradation. However, its effectiveness depends upon the dyestuff and the type of fabric. This method also provides a good bottom for re-dyeing.

Upgrading of Fats and Oils: Chlorine dioxide is effective in the bleaching of fats and oils. The process is simple and low cost and since it eliminates the need for a filter medium, it produces a higher yield than other methods. (About 30% of the weight of the filter residue, which is generally discarded, is tallow.) Problems such as storage and handling of the filter medium and disposal of filter residues are eliminated as well.

References: Chlorine Dioxide, W.J. Masschelein, 1979. Practical Chlorine Dioxide, Greg D. Simpson, PhD, 2021.

SODIUM CHLORITE PRODUCT GRADES

OxyChem sodium chlorite is an excellent source of chlorine dioxide. Sodium chlorite is available in both dry and liquid forms. The dry forms contain approximately 80% Sodium chlorite, and the solutions range from 7.5% to 40% sodium chlorite. Both forms are available for EPA-registered and non-registered applications. Some of the chemical and physical properties of eight of Oxy's most popular products are given below.

Properties of

Technical Sodium Chlorite - Dry

Sodium Chlorite, min (%)	77.5
Sodium Chloride, (%)	11-19
Appearance	white flakes
Bulk Density (lb/ft ³)	Loose 53 Packed 69

Inert Ingredients, sodium salts, and water (%)6.0

Properties of

Technical Sodium Chlorite - Solution 50

Sodium Chlorite, min (%)	35.9
Sodium Chloride, max (%)	3.5
Water (%)	56.4 – 64.1
Density @ 35°C (lb/gal)	~11.1
Crystallization Point (°C)	~15
Appearance	slightly cloudy, pale yellow

Inert Ingredients, mixture of sodium salts.

**Properties of
31% Active - Sodium Chlorite Solution**

Sodium Chlorite, min (%)	30.5
Sodium Chloride, max (%)	3.5
Inert Ingredients, mixture of other sodium salts (%)	3 - 4
Water, (%)	61.5 – 69.5
Appearance	clear, pale yellow
Density @ 25°C (lb/gal)	10.76
Crystallization Point (°C)	3

**Properties of
Technical Sodium Chlorite - Solution 31.25**

Sodium Chlorite, min (%)	24.25
Sodium Chloride, max (%)	3.0
Inert Ingredients, mixture of other sodium salts (%)	3 - 4
Water, (%)	68.25 – 75.75
Appearance	clear, pale yellow
Density @ 25°C (lb/gal)	10.21
Crystallization Point (°C)	-8

**Properties of
Technical Sodium Chlorite - Solution 18.75**

Sodium Chlorite, min (%)	15.0
Sodium Chloride, max (%)	3.0
Inert Ingredients, mixture of other sodium salts (%)	3 - 4
Water, (%)	80.8 – 85.0
Appearance	clear, pale yellow
Density @ 25°C (lb/gal)	9.4
Crystallization Point (°C)	-8

**Properties of
Textone®**

Sodium Chlorite, min (%)	74
Sodium Chloride, (%)	9 - 22
Inert Ingredients, sodium salts and water (%)	8
Appearance	white flakes
Bulk Density (lb/ft ³)	Loose 53 Packed 69

**Properties of
Textone® XL**

Sodium Chlorite, min (%)	30.5
Sodium Chloride, max (%)	3.5
Inert Ingredients, mixture of other sodium salts (%)	3 - 4
Water, (%)	61.5 – 69.5

Appearance	clear, pale yellow
Density @ 25 °C (lb/gal)	10.76
Crystallization Point (°C)	3

**Properties of
Textone® L**

Sodium Chlorite, min (%)	24.25
Sodium Chloride, max (%)	3.0
Inert Ingredients, mixture of other sodium salts (%)	3 - 4
Water, (%)	70.75 – 75.75
Appearance	clear, pale yellow
Density @ 25°C (lb/gal)	10.21
Crystallization Point (°C)	-8

SAFETY AND HANDLING

Shipping Information

OxyChem Technical Sodium Chlorite is registered with the Environmental Protection Agency (EPA) for a number of pesticidal applications as governed by Federal Insecticide, Fungicide, and Rodenticide Act (FIFRA). Technical Sodium Chlorite Dry is available in 100-lb drums. Technical Sodium Chlorite Solution 50, Technical Sodium Chlorite Solution 31.25 and 31% Active Sodium Chlorite Solution are available in 55-gallon drums, 330 - gallon non-returnable totes, tank trucks, and railcars.

Safety and Handling

The following summary of health and safety information is not intended to be complete. For complete information, read the current Material Safety Data Sheet (SDS). To obtain an SDS, contact OxyChem's HESS Department or go to [OxyChem's Internet Website](#).

TOXICOLOGICAL PROPERTIES

Sodium chlorite is toxic by ingestion. Sodium chlorite may cause anemia by oral exposure and has a dermal exposure of 5-10%. Dry sodium chlorite and sodium chlorite solutions have an oral LD₅₀ (rat) of 389 mg/kg. Sodium chlorite dry and solution

products have a dermal LD₅₀ (rabbit) of greater than 2 g/kg. Sodium chlorite can produce severe irritation or burns to the skin and eyes. Corneal damage can occur if not washed immediately from the eyes.

PERSONNEL PROTECTION

When there is a potential for contact while handling sodium chlorite solutions, chemical goggles, face shield, neoprene gloves, chemical apron, and boots should be worn. A respiratory protection program that meets [29 CFR 1910.134](#) must be followed whenever workplace conditions warrant the use of a respirator. Wear a NIOSH approved acid gas respirator with a dust/mist filter if any exposure is possible. Additionally, for dry sodium chlorite,



wear a chemical resistant suit. Local exhaust is required where exposure to dust or mist might occur.

If sodium chlorite is spilled on clothing, remove, and rinse contaminated clothing with water at once to avoid the potential of fire.

FIRST AID

Eyes: Immediately flush eyes with large amounts of water for at least 15 minutes while frequently lifting the upper and lower eyelids. Consult a physician immediately.

Skin: Remove contaminated clothing. Immediately flush exposed skin areas with large amounts of water for at least 15 minutes. Consult a physician if burning or irritation of the skin persists. Contaminated clothing must be rinsed with water multiple times and then laundered before reuse.

Ingestion: DO NOT induce vomiting. Drink large quantities of water. Consult a physician immediately. DO NOT give anything by mouth if the person is unconscious or having seizures.

Inhalation: Move patient to fresh air and monitor for respiratory distress. If coughing or difficulty in breathing develops, administer oxygen, and consult a physician immediately. In the event that breathing stops, administer artificial respiration and obtain emergency medical assistance immediately.

Notes to Physician: Treat as a corrosive due to the pH of this material. For prolonged exposures and significant exposures, consider delayed injury to exposed tissues. There is no specific antidote. Treatment is supportive care. Follow normal parameters for airway, breathing, and circulation. Ingestion of even small amounts of solution should be closely monitored for methemoglobinemia, hemolysis, and glutathione depletion, followed by renal failure. This chemical acts similarly to its related compound chlorate, and produces a drug

induced G6PD deficiency. Methylene blue has not been reported as effective. Consult the PubMed Case Report PMID 22996135 for the case description and treatment utilized. Chlorine dioxide vapors are emitted when this product contacts acids or chlorine. If these vapors are inhaled, monitor patient closely for delayed development of pulmonary edema which may occur up to 48-72 hours post-inhalation. Following ingestion, neutralization and use of activated charcoal is not indicated. In vitro studies have shown that activated charcoal does not adsorb chlorate/chlorite ions. The benefit of decontamination after ingestion is not certain and not recommended.

STORAGE AND HANDLING

Do not contaminate sodium chlorite with incompatible materials such as dirt, organic matter, oxidizers, reducing agents, chemicals, soap products, solvents, acids, paint products, or combustible materials. Do not store or transport sodium chlorite with incompatible materials. Contamination may start a chemical reaction with generation of heat and emission of chlorine dioxide (a poisonous, explosive gas). A fire or explosion may result. Triple rinse empty containers thoroughly with water and dispose of in accordance with label instructions.

Dry sodium chlorite. Do not expose to moisture during storage as it will cause clumping of the flakes, Store in the original container, in a cool, dry, well ventilated area away from direct sunlight. Always replace cover tightly. Mix only into water using a clean, dry scoop dedicated and labeled for this product alone.

Keep away from flame or any burning material (such as a lighted cigarette). If fire occurs, extinguish with plenty of water. Cool any unopened drums near the fire by spraying water on them.

Sodium chlorite solutions. Store in clean, closed, non-translucent containers. Exposure to sunlight or ultra-violet light will reduce product strength.

Do not allow solution to evaporate to dryness; this product becomes a fire or explosion hazard if allowed to dry and can ignite in contact with combustible materials.

SPILL AND LEAK PROCEDURES

In the event of a spill or leak, remove all sources of ignition. Wear National Institute for Occupational Safety & Health (NIOSH) approved positive pressure, self-contained breathing apparatus with a chemically impermeable, fully encapsulated suit. Follow Occupational Health & Safety Administration (OSHA) regulations for respirator use (see [29 CFR 1910.34](#)).

Sodium chlorite, dry, is a fire or explosion hazard if contaminated with combustible material. Clean up in a manner to avoid contamination. Lightly wet spilled material and then pick up, by using a clean, dry, scoop or shovel and placed into a clean, dry, container. Do not return spilled material to the original container. Isolate the recovery container outside or in a well-ventilated area and hold for proper waste disposal. Do not seal the container immediately but wait 24-hours before sealing. Flush any residual material with large quantities of water.

Sodium chlorite solution also becomes a fire or explosion hazard if allowed to dry and can ignite on contact with combustible material. Continue to keep sodium chlorite products damp. Contain spilled material by diking or absorbing with clay, or non-flammable commercial absorbents. Do not return spilled material to original container. Place in a clean container and isolate outside or in a well ventilated area. Do not seal the container. Flush any residual material with large quantities of water.

DISPOSAL

Spill residues may be a hazardous waste as defined in [40 CFR 261](#). The EPA hazardous waste designation for dry sodium chlorite waste is D001 and sodium chlorite solution waste has the waste designation of D002. As a hazardous waste, it will

be subject to the Land Disposal Restrictions under [40 CFR 268](#) and must be managed accordingly. As a hazardous waste solution or solid, it must be disposed of in accordance with local, state, and federal regulations in a permitted hazardous waste treatment, storage, and disposal facility.

REGULATORY INFORMATION

All persons transporting, storing, handling, and using sodium chlorite must comply with applicable federal, state, and local regulations. The following summaries of the regulatory requirements are not intended to be complete or to represent summaries of all relevant requirements. Rather, these summaries describe the areas creating most questions from involved parties. These summaries also do not touch upon any similar state or local regulations, some of which may impose additional or different obligations from those imposed by federal regulations. All parties are responsible for complete review of applicable regulations pertaining to their own operation. Contact OxyChem Technical Services group for additional information.

EPA REGISTRATION

When used as the parent chemical for on-site production of chlorine dioxide in pesticidal applications, sodium chlorite is governed by the Federal Insecticide, Fungicide and Rodenticide Act (FIFRA) ([40 CFR 152, Pesticide Registration & Classification Procedures](#)). This means that the sodium chlorite sold for this purpose must be registered with the EPA and must be used in accordance with the directions listed on the labels.

Pesticidal uses of chlorine dioxide generated by sodium chlorite are biocidal, disinfecting, or sterilizing in nature. Examples of such uses are as a bactericide or slimeicide in treatment of drinking water, processing plant flume water, and rinse water in produce packing facilities; as a slimeicide in recirculating cooling waters; and as a micro biocide in oil recovery operations.

OxyChem technical sodium chlorite products are registered for these applications under the following EPA Registration Numbers:

5382-41 Technical Sodium Chlorite Solution 50
5382-42 Technical Sodium Chlorite
5382-43 Technical Sodium Chlorite Solution 31.25
5382-44 Technical Sodium Chlorite Solution 18.75
5382-45 31% Active Sodium Chlorite
21164-6 Akta Klor 25
21164-9 Akta Klor 7.5

FOOD AND DRUG ADMINISTRATION (FDA)

[21 CFR Parts 1 to 1402](#)

The Federal Food, Drug, and Cosmetic Act (FFDCA) authorizes the assessment of the safety of ingredients in food, drugs, and related products. The present FFDCA was passed in 1938. Later amendments have been added to develop the current food and drug law.

FDA regulations can be found in [21 CFR Parts 1 to 1402](#). The application of sodium chlorite and chlorine dioxide is a complex issue. It is often difficult to identify the regulatory agency that is responsible for overseeing the use of sodium chlorite and/or chlorine dioxide in a particular segment of the food processing industry. Please contact OxyChem's Technical Services Department to assist with determining which agency has jurisdiction over your specific use of sodium chlorite and/or chlorine dioxide.

The manufacturing process for OxyChem sodium chlorite product line does not incorporate all of the measures specified in the Food and Drug Administration's current Good Manufacturing Practices (cGMP). It is the responsibility of the user to assess their use of sodium chlorite products in food, feed, or pharmaceutical related applications and to determine whether appropriate regulatory requirements are being met.

UNITED STATES DEPARTMENT OF AGRICULTURE (USDA)

USDA authorizes the inspection and regulation of meat, poultry, dairy products, and eggs. Meat and meat products are outside FDA's jurisdiction except for product labeling where meat products are commingled

with fabricated food. USDA's role in other food products is production oriented only. The regulatory aspects, such as monitoring pesticide residues, are left to FDA. In addition to the inspection programs administered by USDA, it also establishes and administers several food and nutrition related programs.

Pursuant to the [Meat Inspection Act and Poultry Inspection Act, USDA](#) is extensively involved in the inspection and regulation of meat and poultry products at all states of production. After the food products have left the USDA inspection plant, FDA and USDA have concurrent authority for establishing safeguards and regulating the meat and poultry products. [FDA Compliance Policy Guide No. 7100.1](#). Besides the initial inspection of meat and poultry, the USDA approves new plant construction and equipment, develops, and monitors plant sanitation standards, and conducts technical training of inspection personnel. Additionally, to ensure compliance with USDA procedures, the USDA review shipping, handling, and all other functions performed by allied industries engaged in the transportation, storage, and distribution of meat and poultry products to assure that the products remain unadulterated and truthfully labeled. References: [Federal Publications Inc., "Practical Food Law", Course Manual, 22, 1993](#).

USDA regulations can be found in [7 CFR Parts 1 to 5099](#).

CLEAN AIR ACT

The federal Clean Air Act was enacted in 1970, with several amendments, including a major overhaul in 1990. The Act provides the regulatory vehicle for prevention and control of discharges into the air of substances that may harm public health or natural resources. This Act consists of eleven titles including Title I (non-attainment provisions) and Title III (hazardous air pollutants). Sodium chlorite is not considered a VOC or hazardous air pollutant and is not regulated under the Clean Air Act.

Chlorine dioxide is on the [EPA's List of Regulated Toxic Substances and Threshold Quantities](#) as proposed to be regulated in the Accidental Release Prevention provision of Title III of the Act. A 1,000 pound threshold quantity currently serves as the trigger for the application of these rules in reference to chlorine dioxide.

FEDERAL WATER POLLUTION CONTROL ACT (CLEAN WATER ACT)

Sodium chlorite is a controlled substance in water media. The primary statutory mechanism for controlling water pollution is provided by the Federal Water Pollution Control Act (FWPCA). The FWPCA was amended in 1972 by the Federal Water Pollution Control Act Amendments, in 1977 by the Clean Water Act, and in 1978 by the Clean Water Act Amendments. Most people refer to this growing statute simply as the Clean Water Act (CWA). Regulations promulgated pursuant to the CWA can be found throughout [40 CFR Parts 104-140](#).

Users of sodium chlorite who generate a wastewater stream should be aware that regulations promulgated pursuant to the Clean Water Act most likely affect them. The basic prohibition of the CWA is that it is unlawful for any person to discharge, without a permit, any pollutant from a point source into navigable waters of the U.S. As discussed under the Community-Right-to-Know Section of this manual, sodium chlorite is considered a hazardous substance.

As a hazardous substance, any discharge of sodium chlorite to waters of the U.S. requires a permit. Sodium chlorite users should contact their state regulatory agency to obtain information on applying for a permit consistent with the Clean Water Act requirements. These permits operate under a CWA program called the National Pollutant Discharge Elimination System (NPDES) and are generally referred to as NPDES permits. Pollutant limitations contained in these permits are, in part, based on federal or state effluent limitations.

Effluent limitations are set by industry category and are contained in [40 CFR Parts 405 through 471](#). Pollutant limitations may also be set by Best Management Practices (BMPs), Best Practicable Control Technology (BPT), Best Conventional Control Technology (BCT), Best Available Technology Economically Achievable (BAT), Health Based Toxic Effluent Standards, Water Quality Standards, or Water Quality Management Plans.

If a user of sodium chlorite discharges wastewater effluent, not to waters of the U.S. but to a Publicly Owned Treatment Works (POTW) or Sewer Authority, then the user will need a permit from the POTW which may set permit limits for pollutants in the wastewater stream. Effluent limits are based on a variety of standards but must meet established EPA Pretreatment Standards. Pretreatment Standards are set on an industry specific basis and can be found in [40 CFR Parts 401-471](#).

Generators planning to discharge to the ground (which is considered a groundwater discharge) or to underground injection wells, must also obtain a permit. Such discharges have to meet the minimum standards and restrictions for these media. These standards and restrictions can be found in [40 CFR Parts 144-149](#).

Regulations promulgated under the CWA include the Stormwater Regulations. Under these regulations, an owner/operator must apply for a Stormwater Permit under NPDES if the facility is being operated under a Standard Industry Classification Code (SIC) as a manufacturer (codes 2000 - 3999), and if the facility in question discharges stormwater directly to waters of the U.S.

For more information on Stormwater Permitting, call your state water authority or review the requirements on the EPA and state web sites.

RESOURCE CONSERVATION AND RECOVERY ACT (RCRA)

Persons who generate, transport, treat, store, or dispose of waste sodium chlorite must comply with EPA regulations concerning hazardous waste management. Those regulations are published beginning at [40 CFR Part 260](#).

Sodium chlorite solutions are classified in [40 CFR 261](#) as a characteristically hazardous (*i.e.*, corrosive) waste due to a pH of greater than or equal to 12.5. The EPA waste code for corrosive wastes is D002.

Sodium chlorite dry products are classified in [40 CFR 261](#) as a characteristically hazardous (*i.e.*, ignitable) waste. The EPA waste code for ignitable wastes is D001.

Other hazardous waste codes may apply, and it is the waste generator's responsibility to properly classify each waste.

RCRA Land Disposal Restrictions in [40 CFR 268.9](#), establish treatment standards for hazardous wastes before they can be placed in a RCRA landfill. This rule requires that the hazardous characteristic must be removed from the waste before it is disposed of. If this hazardous characteristic remains, then the hazardous waste must be manifested for disposal or treatment at a permitted hazardous waste treatment, storage, or disposal facility.

HANDLING AND STORAGE

The following information on materials and equipment for handling and storing sodium chlorite liquid is meant to serve as a general guideline only. A number of factors will influence the selection of materials and equipment. Physical properties of the solution being handled will be of primary importance. All equipment purchased for handling and storing sodium chlorite liquid should be verified by the manufacturer or vendor to be suitable for use under the conditions specified.

The primary concern when handling and storing liquid sodium chlorite is freeze-up and solidification which can occur with certain concentrations of material. Solidification will plug pipelines, valves, and other equipment.

If the customer plans to use Solution 50, a heating system is required. Other diluted solutions, such as Solution 31.25, should not require any heating except in very cold environments.

MATERIALS OF COMPATIBILITY

Tanks

Tanks should be of closed top construction to prevent product contamination. The tank vapor space should be adequately vented to prevent chlorine dioxide gas accumulation above explosive decomposition limits.

Tank materials of construction:

1. Fiberglass reinforced polyester with Hetrion 922 resin or equivalent, color natural, with UV protection.
2. High density polyethylene (HDPE)
3. Titanium

Fiberglass Reinforced Plastic (FRP) construction with no internal insulation. Nozzles should include truck unloading vent, and pump suction as a minimum. Nozzles should be provided to allow a local level and

temperature indication. Manways should also be provided to allow access to the interior of the tank.

Pumps

Pumps are a typical source of leakage around glands and packing. This type of spillage should be promptly cleaned up and the area washed down with water. The water should then be drained into an industrial sewer in accordance with the regulations that govern wastewater discharges in your area. Greaseless lubricants should be used in areas where spilled material or dust from dried material may come in contact with the lubricants or the housings containing those lubricants.

Pumps should not be run against closed valves. This may result in heating the sodium chlorite solution to above its decomposition temperature.

The pump should be a centrifugal type with all 316 SS wetted parts. The seal for the pump should be a double mechanical type. Motor for the pump should meet local requirements and codes.

Pump materials of construction (Wetted Parts):

1. 316 SS
2. Polypropylene
3. Seal type:
Continual running = Dynamic
Start/Stop = Double Mechanical

Piping

Design the piping system to avoid space which may trap gases. The piping system should be designed to accommodate thorough flushing or complete drain down especially in cold climates where low temperatures may induce crystallization of the sodium chlorite liquid in the piping system.

The recommended material is CPVC piping. Other materials such as vinyl esters and Teflon piping may be used. Carbon steel and stainless steel are not recommended. Minimum pipe size should be 1 1/2 inches.

Piping materials of construction:

1. CPVC
2. Vinyl Ester FRP
3. Teflon lined pipe

Heat tracing and insulation (calcium silicate or equivalent) may be appropriate where solution freezing point is exceeded. However, if that approach is used, a temperature controller should be used to keep from generating any "hot" spots in the piping. Heat tracing temperature settings should be specific for the product being used.

UNLOADING SODIUM CHLORITE TANK TRUCKS

Preparation

The unloading area should be arranged so that any spillage that might occur will be properly contained for recovery. The unloading area should be level and constructed to allow the truck to be driven away in a forward direction.

The truck's parking brakes must be set. When the unloading operation is performed in an area accessible to untrained personnel, a safety rope bearing "DANGER - Sodium Chlorite" signs should be set up around the unloading area.

Unloading operations must be carried out under adequate supervision and by properly trained employees.

Precautions

Trained, properly equipped personnel are required for safe unloading of sodium chlorite tank trailers. The unloading operation should be continuously watched and if it should be necessary for the operator to leave, the operation should be shut down.

If a tank trailer sample is required, all pressure must be bled off the tank trailer before opening the manway.

Emergency showers and eye wash fountains should be located in the unloading area and easily accessible in case of accidental exposure. ANSI Z358.1 is the standard for all eye wash and safety shower requirements and can be purchased at the above link to the ANSI Webstore.

Smoking should not be allowed in the unloading area.

Unloading should be done during daylight hours. If it is necessary to unload after dark, adequate lighting must be provided.

Unloading with Compressed Air

Before starting the unloading operation, it must be verified that the storage tank is adequately vented and that the tank will hold the entire contents of the tank trailer. The tank vent should be properly sized for the air surge which occurs at the end of the product transfer which is approximately 1350 SCFM (Standard Cubic Feet per Minute). (**See Figure 1**)

Follow these instructions:

1. Connect the air line from the trailer compressor to the trailer air inlet valve.
2. Connect one end of the sodium chlorite unloading hose to the product discharge valve on the trailer and the other end to customer's storage tank inlet valve.
3. Open the product outlet valve on the sodium chlorite discharge piping on the trailer and open the inlet valve on storage tank.
4. Slowly apply air pressure until there is a steady flow of product into the storage tank. The air pressure in the trailer must not be allowed to exceed 30 psig.
5. When the trailer is empty, shut off compressor or other source of air pressure.
6. Allow the unloading line to be blown empty into the storage tank; then close the product outlet valve on the tank trailer.
7. Immediately close the product inlet valve to the storage tank.
8. Bleed the pressure off the product hose by slowly opening the drain valve at the trailer discharge or at the storage tank inlet. Any residual product remaining in the hose should

be drained to a suitable chemical sewer. Disconnect the unloading line from the trailer and the storage tank. OxyChem recommends that the customer provide a drain valve between the hose connection and inlet valve to depressurize and drain the product unloading hose prior to disconnection.

9. If any sodium chlorite has spilled on the outside of the truck or on the ground, it should be washed off with plenty of water and drained into an appropriate chemical sewer.

Unloading by Pump

Before starting the unloading operation, it must be verified that the storage tank will hold the entire contents of the tank trailer. Either a centrifugal or rotary pump proven suitable for sodium chlorite must be provided by the customer for this type of unloading.

Follow these instructions:

1. Be sure the manway cover is open and remains open during the unloading operation to ensure the tank trailer is properly vented.
2. Connect one end of the sodium chlorite unloading hose to the product discharge valve on the trailer and the other end to the customer's pump inlet valve.
3. Open the product discharge outlet valve on the trailer and check for leaks.
4. Open the pump product inlet and outlet valves.
5. Start the pump and continue pumping until the tank trailer is empty.
6. After the tank trailer has been emptied, shut off the pump and immediately close the valve on the pump inlet piping and close the trailer discharge valve.

7. Bleed the pressure off the product hose by slowly opening the drain valve at the trailer discharge or at the pump inlet. Any residual product remaining in the hose should be drained to a suitable chemical sewer. Disconnect the unloading line from the trailer and the pump inlet. OxyChem recommends that the customer provide a drain valve between the hose connection and pump inlet valve to depressurize and drain the product unloading hose prior to disconnection.
8. Close and secure the top manway cover.

Unloading with Compressed Air

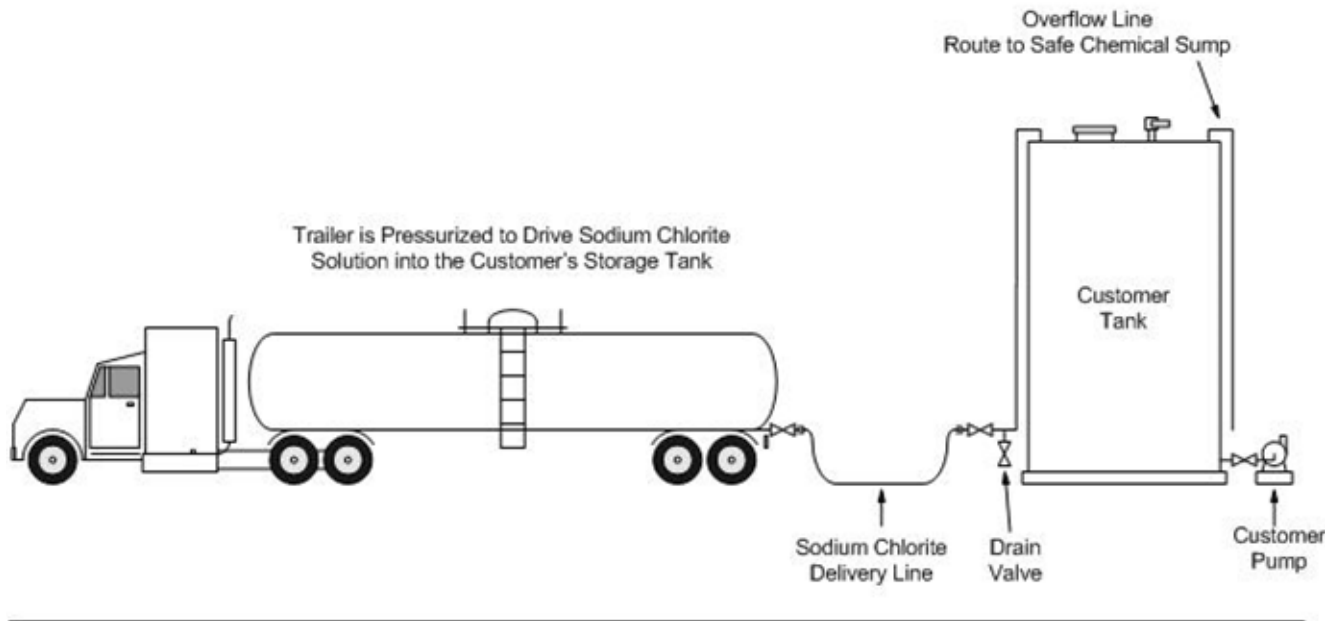

Unloading by Pump

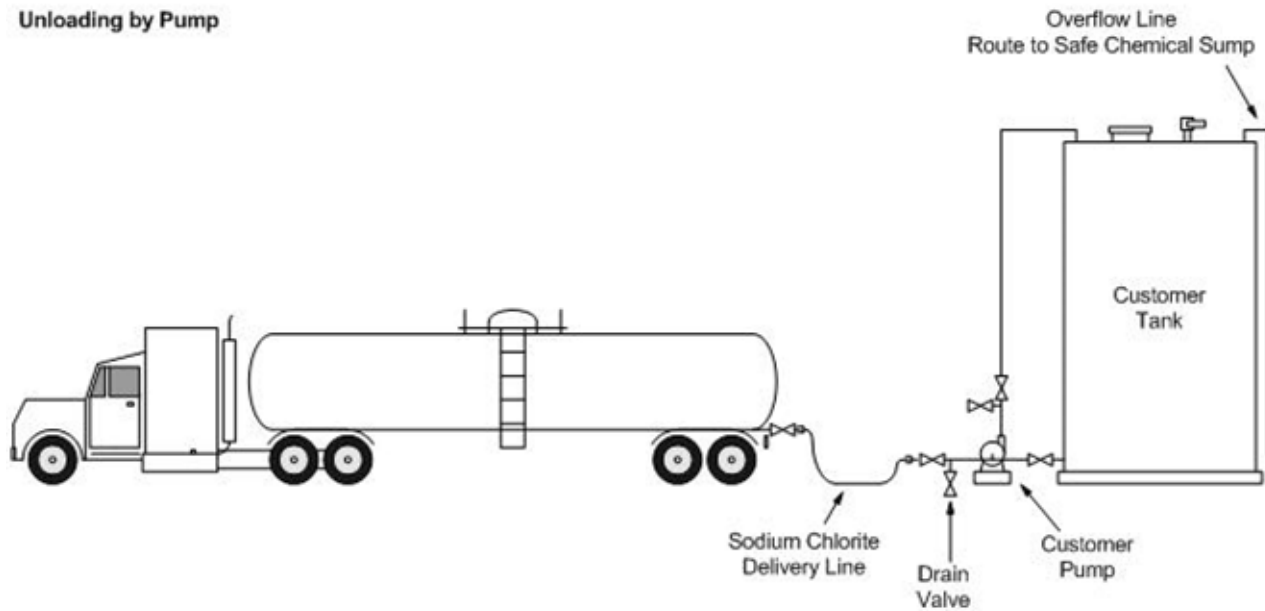

Figure 1: Unloading Sodium Chlorite Tank Trucks

UNLOADING SODIUM CHLORITE TANK CARS

The following instructions for unloading sodium chlorite tank cars are based on good engineering practices along with many years of industrial experience. These instructions are meant to serve as a general guideline only and may not be appropriate for all unloading circumstances. The operation of valves and equipment which may be present in the customer's system is also not included. If material is being offloaded into a bottom fill storage tank, an offloading sequence should be followed that prevents back-flow of material from the storage tank to the tank car due to back-pressure exerted by Sodium Chlorite in the storage tank.

Preparations

The unloading track should be level. Once the car is spotted, set the hand brake, and block the wheels. The unloading area should be designed so that any spillage that might occur will be properly contained for recovery. The unloading area should be secured to prevent the entry of untrained or unauthorized persons.

Department of Transportation (DOT) regulations [49 CFR 174.67 \(a\)\(2\)](#) and [\(a\) \(3\)](#) include an outline of steps to be taken and signage to be placed in order to properly spot and secure the tank car and warn that unloading is taking place. Unloading personnel should consult and be familiar with the latest edition of this regulation.

Personnel unloading sodium chlorite from tank cars must be trained and made responsible for compliance as outlined in [49 CFR 174.67 \(a\)\(1\)](#). Unloading personnel should consult and be familiar with the latest edition of this regulation.

Receiving personnel should verify the correct product by paperwork and arrange for a sample to be taken from the tank car where required. The line into which material will be offloaded

should be labeled or tagged with the identity of the material being offloaded. Access to top

fittings on the tank car should be provided by safe steps, platforms, or drop-bridges. Guard rails for the protection of personnel must meet OSHA standards. If air padding is used for unloading, the air must be clean and properly regulated. Emergency shut-off equipment is recommended on all product lines.

Precautions

DOT Regulations for unloading [\(49 CFR 174.67\(i\)\)](#) require that throughout the entire period of unloading, and while the tank car is connected to an unloading device, the tank car must be attended by the unloader or monitored by a signaling system that is observed by a designated hazmat employee. If it is necessary to discontinue unloading a tank car for any reason, all valves must be tightly closed and unloading connections disconnected. This is intended to assure that the flow of sodium chlorite from the tank car is carefully controlled, and the tank car can quickly be shut off should problems in unloading develop.

Protective equipment, as described in the Safety and First Aid section of this handbook, must be worn while transferring sodium chlorite from a tank car to a storage tank. Before starting the unloading operation, it must be verified that the storage tank is adequately vented to a properly sized vent system and that the tank will hold the entire contents of the tank car. The storage tank must remain vented throughout the unloading operation. If unloading with compressed air, the tank vent should be properly sized for the air surge that occurs at the end of product transfer, which is approximately 1350 SCFM (Standard Cubic Feet per Minute) based on 30 psig air pressure. If a tank car sample is required, all pressure must be bled off the tank car before opening the manway.

Well-marked emergency showers and eye wash fountains must be located in the immediate work area and easily accessible in case of accidental

exposure. These units should be tested on a weekly basis as well as prior to transferring product to ensure correct operation per ANSI Z358.1 standards.

Unloading should take place during daylight hours. If it is necessary to unload after dark, adequate lighting must be provided. If a tank car must be moved before it is completely unloaded or if it is necessary to discontinue unloading a tank car for any reason, [49 CFR 174.67\(j\)](#) specifies disconnection and closure operations that must be performed. [49 CFR 174.67\(l\)](#) and [\(k\)](#) specify disconnecting and closure operations that must be performed after unloading is completed. Unloading personnel should consult and be familiar with the latest edition of these regulations.

UNLOADING PROCEDURES FOR TANK CARS

All sodium chlorite tank cars are unloaded from the top. They are unloaded through the product discharge pipe by using either compressed air or a pump. OxyChem tank cars are equipped with one a manway configurations shown in the photos blow marked Figures 1 – 3.

UNLOADING WITH COMPRESSED AIR

Before starting the unloading operation, it must be verified that the storage tank will hold the entire contents of the tank car. The recommended compressed air supply assembly referred to in the following procedures should consist of a check valve, pressure reducing valve, water separator, shut-off valve, a pressure bleed-off valve connected and a pressure relief valve set at 30 psig. (See Figure 5).

Follow these instructions:

1. Carefully remove the cap from the camlock fitting on the one inch valve provided on the tank car and cautiously open the air valve on the tank car to bleed pressure from the tank car.
2. Connect the air supply line to the one inch camlock fitting.
3. Carefully remove the three inch cap from the camlock fitting on the three inch liquid discharge valve. NEVER OPEN THE VALVE ON THE DISCHARGE PIPE UNTIL THE TANK CAR HAS BEEN FULLY VENTED AND DEPRESSURIZED. If the valve is opened before venting the tank car, product could be forced up the discharge pipe and spray the person opening the valve.
4. Connect the product unloading line to the tank car and the other end to the storage tank inlet.
5. Open product inlet valve on storage tank.
6. Open valves on the air supply assembly and the tank car air valve; apply air pressure slowly through the air valve until a steady stream of product is flowing into the tank. The air pressure in the tank car should not be allowed to exceed 30 psig.
7. When the tank car is empty there will be a drop in pressure and the sound of air rushing through the discharge pipe. When this occurs, shut off the air inlet valve.
8. When the unloading line is blown free of product, close the inlet valve to the storage tank.
9. Slowly open the pressure bleed-off valve on the air line to vent the car to the and allow the pressure in the tank car to be released. This will enable the product in the tank car dip leg to drain back into the tank car.
10. When the pressure gauge on the air line reads zero, close vent valve. Cautiously disconnect the air assembly from the tank car. Replace the camlock cap on the closed air valve.

11. Bleed the pressure and residual product from the product hose by slowly opening the drain valve between the hose connection and storage tank inlet valve. Disconnect the unloading hose. Contain any residual product remaining in the hose for proper recovery in dedicated, labeled container.
12. Disconnect the product unloading line from the tank car. Replace the cap on then camlock fitting on the closed product discharge valve.

Figure 2

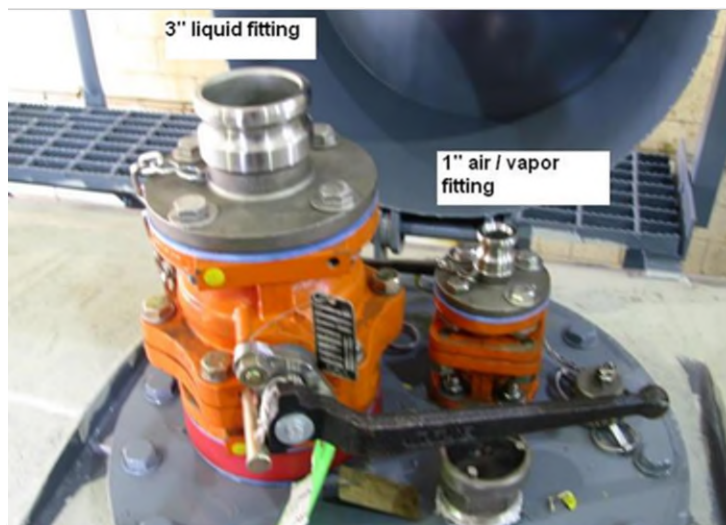

Product Inlet/Outlet and Air Inlet valves

Figure 3



Pressure Relief Device

Figure 4

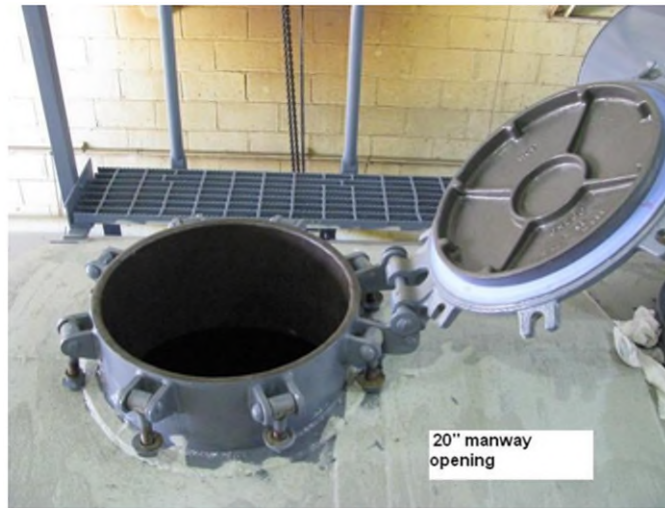

Manway Opening

Figure 5

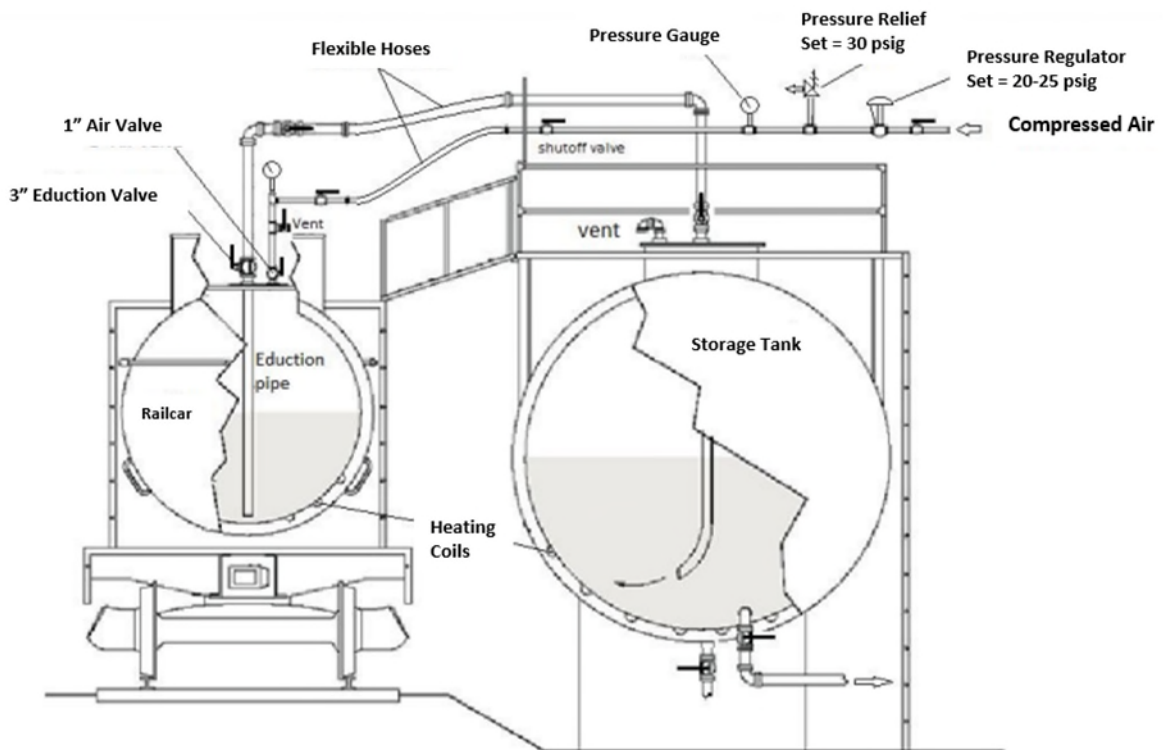

UNLOADING BY PUMP

Before starting the unloading operation, it must be verified that the storage tank will hold the entire contents of the tank car. A self-priming, centrifugal pump proven suitable for sodium chlorite service must be provided by the customer for this type of unloading. (See Figure 6)

Follow these instructions:

1. Carefully remove the cap from the camlock fitting on the one inch valve provided on the tank car and cautiously open the air valve on the tank car to bleed pressure from the tank car.
2. Connect the air supply assembly to the one inch camlock fitting.
3. Carefully remove the three inch cap from the camlock fitting on the three inch liquid discharge valve. NEVER OPEN THE VALVE ON THE DISCHARGE PIPE UNTIL THE TANK CAR HAS BEEN FULLY VENTED AND DEPRESSURIZED. If the valve is opened before venting the tank car, product could be forced up the discharge pipe and spray the person opening the valve.
4. Leave the air valve open for make-up air while unloading to avoid pulling a vacuum on the tank car. The dome lid may also need to be opened slightly to allow for sufficient make-up air.
5. Connect one end of the product unloading line to the product discharge three inch camlock fitting on the tank car and the other end to the pump inlet.
6. Open the pump product inlet valve and storage tank inlet valve.
7. Next, start the pump and continue pumping until the tank car is empty. High-volume pumps equipped amp-sensing cutoff switches may shut down prematurely due to vortex action within the car near the end of unloading. If this occurs, restart pump and if possible, throttle pump to assure complete unloading of the tank car.
8. When the tank car is empty, shut off the pump and immediately close the valve at the pump inlet. Close and secure the dome lid if opened.
9. Bleed the pressure and residual product from the product hose by slowly opening the drain valve between the hose connection and the pump inlet valve. Disconnect the unloading hose. Contain any residual product remaining in the hose for proper recovery.
10. Replace the caps on the camlock fittings on the discharge valve and bolt the flange the air valve.

Figure 6

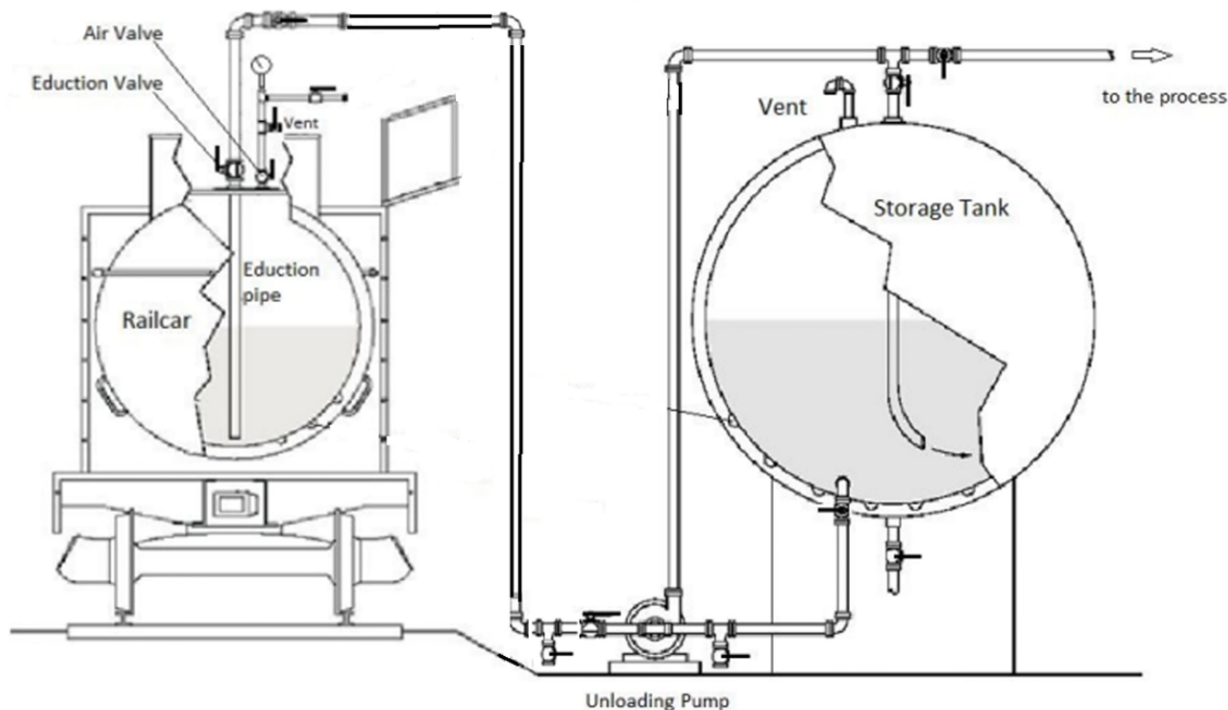

PREPARING EMPTY TANK CARS FOR RETURN

When returning empty tank cars, the following procedures must be followed:

1. De-pressurize the tank car.
2. Use water to wash off any product which may have spilled onto the tank car when disconnecting and draining the unloading line. This will prevent damage to the car and possible exposure to railroad personnel who will be handling the car. All wash down water must be recovered or drained to a suitable chemical sewer.
3. DOT regulations [\(49 CFR 173.31\(d\)\(1\)\)](#) require the persons offering the returned empty tank car to ensure that the tank car is in proper condition and safe for transportation. Specifically, all tank car openings must be properly secured prior to shipment. The person offering the car for shipment must also perform an external visual inspection that includes:
 - a. [\(d\)\(1\)\(i\)](#) – the tank shell and heads, except where insulation precludes an inspection, for abrasion, corrosion, cracks, dents, distortions, defects in welds, or any other condition.
 - b. [\(d\)\(1\)\(ii\)](#) – the piping, valves, fittings and gaskets for corrosion, damage, or any other condition.
 - c. [\(d\)\(1\)\(iii\)](#) – bolts and nuts that may be missing or elements that make the tank car unsafe for transportation.
 - d. [\(d\)\(1\)\(iv\)](#) – inspection and tightening of closures and fastenings by the use of a bar, wrench, or suitable tool.
 - e. [\(d\)\(1\)\(v\)](#) – securement of protective housings.

- f. [\(d\)\(1\)\(viii\)](#) – tank-head puncture resistance system, coupler vertical restraint system and bottom discontinuity protection.
 - g. [\(d\)\(1\)\(ix\)](#) – required tank car markings for legibility.
 - h. [\(d\)\(1\)\(x\)](#) – periodic inspection date markings that are within the prescribed intervals.
4. Ensure that the tank car has proper corrosive placards. They should read “1908”.
 5. Return all cars as promptly as possible. All problems should be discussed with OxyChem Customer Service.
 6. [49 CFR 173.31\(d\)\(2\)](#) outlines the legal ramifications for failure to perform the requirements specified in [49 CFR 173.31\(d\)\(1\)](#).
 7. Personnel offering empty sodium chlorite tank cars for return should consult and be familiar with the latest edition of these regulations.

TECHNICAL DATA

PREPARING A 25% SODIUM CHLORITE SOLUTION FROM OXYCHEM TECHNICAL SODIUM CHLORITE (DRY) PRODUCT.

The following conversions will enable you to blend a 25% sodium chlorite solution from OxyChem Technical Sodium Chlorite (dry) product.

To determine the amount of OxyChem Technical Sodium Chlorite and water needed to prepare a specified number of gallons of 25% sodium chlorite solution you would follow the following steps:

1. Multiply the desired number of gallons of 25% sodium chlorite solution by the weight per gallon of a 25% sodium chlorite solution prepared from OxyChem Technical Sodium Chlorite dry product (10.27 lbs./gal.). This gives you the total weight of the desired volume of sodium chlorite solution.
2. Multiply the total weight of the sodium chlorite solution by 0.25 (25%) to determine the weight of sodium chlorite required to prepare that solution, and then divide the sodium chlorite weight by 0.80 (80%) to determine the amount of dry product (80% NaClO₂ by wt.) required.
3. Now that you know the weight of OxyChem Technical Sodium Chlorite dry product in the desired volume of 25% sodium chlorite solution, subtract that weight from the total solution weight to determine the weight of the water required to prepare the 25% solution. The weight of the water can be converted to gallons by dividing by 8.34 lbs./gal.

Example: How much OxyChem Technical Sodium Chlorite dry product and water is required to prepare 50 gallons of 25% sodium chlorite solution?

$$50 \text{ gals.} \times 10.27 \text{ lbs./gal.} = 513.5 \text{ lbs.}$$

$513.5 \text{ lbs.} \times 0.25 = 128.38 \text{ lbs.}$ of sodium chlorite required to prepare 50 gallons of 25% active sodium chlorite solution.

$128.38 \text{ lbs. NaClO}_2 / 0.8 = 160.48 \text{ lbs.}$ of OxyChem Technical Sodium Chlorite dry product required to prepare the desired volume of 25% sodium chlorite solution.

$513.5 \text{ lbs.} - 160.48 \text{ lbs.} = 353.02 \text{ lbs.}$ of water is required to prepare 50 gallons of 25% sodium chlorite solution.

$353.02 \text{ lbs} / 8.34 = 42.33 \text{ gallons}$ of water is required to prepare the 50 gallons of 25% sodium chlorite solution.

SODIUM CHLORITE SOLUTIONING INSTRUCTIONS:

1. To aid in the solutioning process, the water should be between 100 to 120 degrees F.
2. Mix as you add the 80% Technical Sodium Chlorite dry product.
3. Add sodium chlorite in free flowing flake form.
4. Mix for 30 minutes and sample to verify proper strength.
5. Allow to cool, then drum.

Figure 7 illustrates how crystallization temperature varies with the solution concentration. Crystallization temperature is not necessarily the temperature at which the solution freezes, but instead the temperature at which the sodium chlorite begins to form crystals and fall out of solution. This curve is based on OxyChem solution products and not solutions made from the dry product.

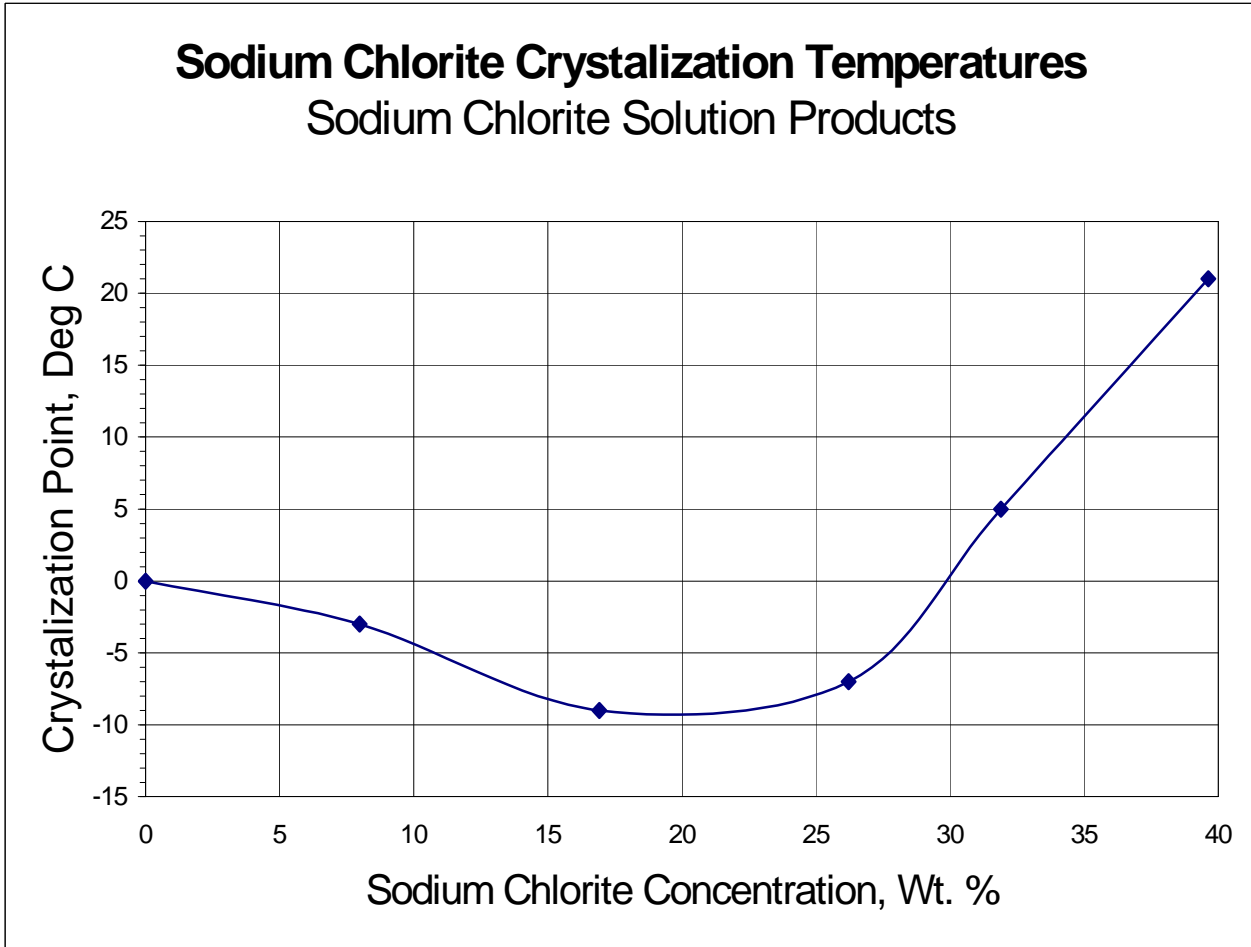

Figure 7: Sodium Chlorite Crystallization Curve

METHODS OF ANALYSIS

Analytical Methods presented here shall be limited to those methods used for quality control, not for field testing. The following OxyChem Standard Methods of Analysis are equivalent to AWWA Standards for Sodium Chlorite [ANSI/AWWA B303-18](#).

DETERMINATION OF SODIUM CHLORITE STRENGTH IN SODIUM CHLORITE PRODUCTS

Method Summary

Sodium chlorite assay is determined in sodium chlorite product samples by iodometric titration of the iodine released when the samples are treated with potassium iodide and hydrochloric acid. The samples are titrated with a standard sodium thiosulfate solution.

Apparatus:

1. 250 ml Erlenmeyer flask.
2. 500 ml Class A Volumetric flask.
3. 20 ml Class A Volumetric pipet.
4. Analytical balance, 3 place.
5. 50 ml burette.

Reagents and Solutions:

1. Potassium Iodide, 5% solution.
2. 1.0 N Hydrochloric Acid.
3. 0.1 N Sodium Thiosulfate standard solution.
4. Starch indicator solution, 5 gpl amylose in water.
5. Deionized water.

Procedure

1. Weigh sample (to the nearest 0.001 grams) into a 500 mL volumetric flask, according to the following table:

PRODUCT GRADE	TARGET WEIGHT
25% Solution	10. grams
31% Solution	8. grams
Solution 50	6.5 grams
Dry Flake	3. grams

2. Dilute to 500 ml and mix well.
3. Rinse a 20 ml Class A pipet with the above solution. Pipet 20 ml of the solution into a 250 ml Erlenmeyer flask containing 100 ml of DI water.
4. Add 40 ml of 5% KI and MIX WELL. (KI MUST be added before HCl.)
5. Add 6.5 ml of 1 N HCl and mix.
6. Titrate with 0.1 N Na₂S₂O₃ to a faint yellow color.
7. Add Starch indicator and continue the titration to a colorless endpoint. Record titer to the nearest 0.01 ml.

Calculations:

$$\text{Wt \%NaClO}_2 = \frac{\text{ml of Na}_2\text{S}_2\text{O}_3 \times \text{N} \times \text{Dilution Factor} \times 2.2612}{\text{Sample Weight in grams}}$$

$$\text{Dilution Factor} = (500/20) = 25$$

$$\text{N} = \text{normality of Na}_2\text{S}_2\text{O}_3$$

simplified calculation:

$$\text{Wt \%NaClO}_2 = \frac{\text{ml Na}_2\text{S}_2\text{O}_3 \times 56.53 \times \text{N}}{\text{Sample Weight}}$$

$$\text{gpl NaClO}_2 = \text{Wt\% NaClO}_2 \times \text{Specific Gravity} \times 10$$

Notes

1. Sodium chlorite is a very strong oxidizing reagent and as such is incompatible with strong reducing agents, finely powdered metals, phosphorus and acids!
2. Keep solid sodium chlorite away from combustible materials, heat, sparks, and open flame!
3. Since potassium iodide will oxidize when exposed to air in acidic conditions, the starch endpoint color may return after the titration is

actually completed. Therefore, record the ml of sodium thiosulfate used at the first clear endpoint.

4. KI **MUST** be added and mixed before 1.0 N HCl. If the HCl is added first, chlorine dioxide will gas off, and the strength will be reported lower than actual.
5. A reagent blank should be run periodically, to insure the purity of reagents. This will mainly be a check on the KI solution. It could possibly become oxidized with chlorine (turning it yellow) which will give erroneously high results.
6. If the alkalinity of the sample is unusually high, 10 ml of 1 N HCl may be needed, rather than 5 ml. The pH needs to be between 1 and 2 for the ClO₂⁻ to oxidize the I⁻ completely. Following is a table showing the relationship between volume of 1.0 N HCl and pH, for a Solution 50 assay:

ml of 1.0 N HCl Added	pH	Assay: NaClO ₂ %
0	9.0	
0.5	6.0	
1.0	5.6	
1.5	5.6	
2.0	5.3	15.1%
2.5	5.2	
3.0	5.1	23.3 %
3.5	5.0	

4.0	4.9	31.6 %
4.5	4.2	
5.0	2.5	37.4 %
5.5	2.1	
6.0	1.9	37.4 %
6.5	1.8	Recommended Target
13.0	1.2	
20.0	1.0	
30.0	0.9	

7. Reaction that occurs when acid is added (KI already present):

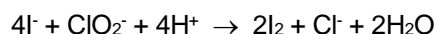

Note that 4 electrons are transferred; thus, equivalent weight of sodium chlorite is molecular weight divided by 4.

8. Reaction that occurs during titration:

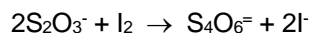

Note that 2 electrons are transferred thus, equivalent weight of sodium thiosulfate is molecular weight divided by 2.

9. Reaction that occurs if acid is added BEFORE KI is added:



The chlorine dioxide will tend to gas out of solution, and thus will not be titrated. Results for NaClO₂ strength will be falsely low.

10. Reaction that occurs if titration is done too slowly, or if too much acid is added:

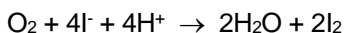

The resulting free iodine is then titrated by thiosulfate, giving falsely high results.

References

1. Mathieson Chemical Corporation, Niagara Falls Quality Control Lab.
2. Aieta et al. "Detn of Chlorine Dioxide, Chlorine, Chlorite, and Chlorate in Water," Journal of AWWA, January 1984.

DETERMINATION OF SODIUM HYDROXIDE AND SODIUM CARBONATE IN SODIUM CHLORITE PRODUCTS

Method Summary

Sodium hydroxide and sodium carbonate are determined in sodium chlorite product samples by an acid/base titration of two samples (one of which has been treated with barium chloride to precipitate barium carbonate), using hydrochloric acid titrant. The difference between the two titrations determines the sodium carbonate present.

Apparatus

1. Two 250 ml Erlenmeyer flasks, with stoppers.
2. Analytical balance, 3 place.
3. Burette, 50 ml.

Reagents

1. 0.1 N Hydrochloric Acid.
2. Phenolphthalein indicator, 5 gpl (grams per liter) in Methanol.
3. Deionized water.
4. Barium Chloride, 100 gpl.

Procedure

1A. Solid Sodium Chlorite Sample:

Weigh 10.0 gm into each Erlenmeyer flask, record the weights to the nearest 0.001 gm, and label the flasks A and B.

1B. Sodium Chlorite Solutions:

1. Pipet 25 ml of sample into each Erlenmeyer flask, record the weights to the nearest 0.001 gm, and label the flasks A and B.
2. To flask A add 50 ml of DI water. Stopper and mix well.
3. To flask B add 40 ml of 10 % BaCl₂. Stopper, mix well, and allow to sit for at least 3 minutes.
4. Add phenolphthalein indicator to each flask.
5. While swirling vigorously, titrate flask A with 0.1N HCl to the absence of pink; record titer to the nearest 0.01 ml.
6. While swirling vigorously, titrate flask B with 0.1N HCl to the absence of pink; record titer to the nearest 0.01 ml. The B titer will be smaller than the A titer.

Calculations:

$$\% \text{NaOH} = \frac{\text{ml B} \times \text{N} \times 4.000}{\text{Weight of Sample B in grams}}$$

$$\% \text{Na}_2\text{CO}_3 = \frac{(\text{ml A} - \text{ml B}) \times \text{N} \times 10.5999}{\text{Average Weight of Samples A and B in grams}}$$

$$\% \text{Total Alkalinity} = (\% \text{Na}_2\text{CO}_3 \times 0.7547) + (\% \text{NaOH})$$

Notes

Sodium chlorite is a very strong oxidizing reagent and as such is incompatible with strong reducing agents, finely powdered metals, phosphorus and acids!

Keep solid sodium chlorite away from combustible materials, heat, sparks, and open flame!

NaClO₂ may degrade the indicator, and more may need to be added when the endpoint is approached.

Swirl flask vigorously during titration to minimize localized reaction of acid with chlorite:



DETERMINATION OF HYDROGEN PEROXIDE IN SODIUM CHLORITE PRODUCTS

Method Summary

Hydrogen peroxide is determined in sodium chlorite product samples by an iodometric titration of the sample using a 0.1 N sodium hypobromite titration solution.

Apparatus

1. 500 ml Erlenmeyer flask.
2. 10 ml volumetric pipet.
3. Analytical balance, 4 place.
4. 50 ml buret.

Reagents

1. Starch indicator solution, 5 gpl.
2. Deionized water.
3. Potassium Iodide, 5% (w/v)
4. 0.1 Normal Sodium Hypobromite solution.

Preparation of 0.1 N Sodium Hypobromite (NaOBr) solution:

- A. Add 1 Liter DI water to a 2 Liter volumetric flask.
- B. Add 17 ml of 50% membrane NaOH.
- C. Add 5.8 ml reagent liquid Bromine.
- D. Stopper and mix well, until reaction ceases.
- E. Dilute to final volume of 2 Liters, mix well, and store in amber bottle.

Standardization

- A. Add 150 ml DI water to a 500 ml Erlenmeyer flask.
- B. Pipet 25 ml of NaOBr solution into flask.
- C. Add 40 ml of 5% KI (or 2 gm KI crystals).
- D. Add 8 ml glacial acetic acid, and 5 drops starch indicator.
- E. Titrate with standard 0.1 N $\text{Na}_2\text{S}_2\text{O}_3$ to a clear endpoint.
- F. Record titer, and calculate as follows:

$$\text{Normality of NaOBr} = \frac{\text{ml Na}_2\text{S}_2\text{O}_3 \times 0.1 \text{ N Na}_2\text{S}_2\text{O}_3}{\text{ml NaOBr}}$$

- G. If the normality of the NaOBr is more than 1% too strong (over 0.101 N), adjust it as follows:

$$\text{Calculate ml DI water to add} = (1975 \times \text{N}) - 1975$$

Procedure

Blank Titration:

1. Add approximately 150 ml of deionized or equivalent water to a 500 ml Erlenmeyer flask.
2. Add 20 ml of 5% KI solution (or 1 gram of KI crystals).
3. Add 2 ml of starch indicator.
4. Titrate the sample using the 0.1 N NaOBr titration solution by adding it dropwise.
5. When a light blue color appears and is permanent the titration is complete.
6. Record the number of mls of 0.1 N NaOBr used to titrate the blank.

Sample Titration:

1. Add approximately 150 ml of deionized or equivalent water to a 500 ml Erlenmeyer flask and tare the flask.
2. Add 20 ml of 5% KI.
3. Add 2 ml of starch indicator.
4. Pipet 10 ml of sample into flask, holding the tip of the pipet below the surface of the liquid. If sample is a solid flake, weigh in 10 grams of sample. Record sample weight.
5. Titrate the sample using the 0.1 N NaOBr titration solution by adding it dropwise.
6. When a light blue color appears and is permanent the titration is complete.
7. Record the number of mls of 0.1 N NaOBr used.

Calculations:

10 ml Liquid Sample:

$$\% \text{H}_2\text{O}_2 = \frac{(\text{ml of NaOBr} - \text{ml Blank}) \times \text{N of NaOBr} \times 0.170074}{\text{Specific Gravity}}$$

Solid Flake Sample:

$$\% \text{H}_2\text{O}_2 = \frac{(\text{ml of NaOBr} - \text{ml Blank}) \times \text{N of NaOBr} \times 1.70074}{\text{Sample Weight}}$$

Notes

1. Sodium chlorite is a very strong oxidizing reagent and as such is incompatible with strong reducing agents, finely powdered metals, phosphorus and acids!
2. Keep solid sodium chlorite away from combustible materials, heat, sparks, and open flame!
3. Hydrogen peroxide is unstable in sodium chlorite solutions and will react with other contaminants in the sodium chlorite sample. For this reason, the samples should be analyzed for hydrogen peroxide as soon as possible.
4. Handle liquid bromine under a fume hood using appropriate protection.
5. Reactions during standardization of NaOBr:

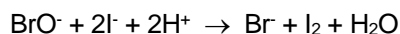

NOTE: Hypobromite oxidizes iodide. A two electron transfer.

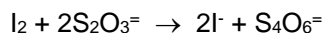

NOTE: Thiosulfate reduces iodine. A two electron transfer.

6. Reactions during analysis of H_2O_2 :
 $\text{H}_2\text{O}_2 + \text{I}^- \rightarrow \text{No Rx in basic solution.}$

NOTE: Solution stays clear.

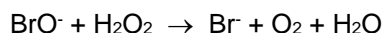

NOTE: Hypobromite oxidizes peroxide. A two electron transfer.

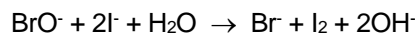

NOTE: Hypobromite oxidizes iodide, forming iodine, which forms a blue complex with starch. A two electron transfer.

DETERMINATION OF SODIUM CHLORATE AND SODIUM SULFATE IN SODIUM CHLORITE BY ION CHROMATOGRAPHY WITH CONDUCTIVITY DETECTION

Method Summary

Chlorate and sulfate levels are determined in sodium chlorite by ion chromatography, using an IONPAC AS9-SC separator column. Sodium chlorite is injected into a DIONEX 2000i/sp ion chromatograph after dilution with DI water. Concentrations of chlorate and sulfate are determined by comparison with response curves and calculated as sodium chlorate and sodium sulfate.

Apparatus

1. Dionex Model 2000i/SP ion chromatograph or equivalent.
2. Dionex Ionpac AS-9 separator column.
3. Dionex Ionpac AG-9 guard column.
4. Dionex AMMS-II Micro Membrane Suppressor.
5. Electronic data handling system.
6. 100 ml volumetric flasks.
7. Disposable transfer pipet.
8. 3 ml plastic disposable syringes.
9. Analytical balance, 4 place.

Reagents

1. Milli-Q Deionized water. (Low conductivity, free from sulfate and chlorate)
2. Sodium Carbonate, ACS Reagent grade Na_2CO_3 .
3. Sodium Bicarbonate, ACS Reagent grade NaHCO_3 .
4. Concentrated Sulfuric Acid, ACS Reagent grade.
5. Stock Eluent Concentrate: Into a 1 liter volumetric flask, weigh 21.978 grams of Na_2CO_3 and 6.301 grams of NaHCO_3 , Dilute to final volume of 1000 ml. Mix thoroughly, store in a labeled plastic container. (200 mM Na_2CO_3 /75 mM NaHCO_3)
6. Working Eluent for chromatograph: Pipet 20 ml of stock eluent into a 2 liter volumetric flask (2mM Na_2CO_3 and 0.75 mM NaHCO_3). Dilute to 2000 ml with Milli-Q DI water.
7. 0.025 N sulfuric acid: To 4 liters Milli-Q deionized water, add 2.8 ml of concentrated sulfuric acid. Mix thoroughly.

- 8. Sodium Chlorate, ACS Reagent grade. NaClO₃.
- 9. Sodium Sulfate, ACS Reagent grade. Na₂SO₄.

Procedure

Instrument parameters:

- Sample size: 50 µl
- Columns: Ionpac AG-9 Guard column
Ionpac AS-9 Separator column
- Eluent: 2.0mM Na₂CO₃/0.75mM NaHCO₃
Flow rate= 2.0 ml/min
- Pressure: 850-1400 psig
- Suppressor: AMMS II Micromembrane suppressor
- Regenerant: 0.025N H₂SO₄
Flow rate = 7-10 ml/min
- Sensitivity: 3 µs

1. Start the ion chromatograph and ensure that proper flows of eluent and regenerant are established. Allow the instrument to equilibrate and ensure that a stable baseline is established. Select the appropriate detector output range setting.
2. Weigh sample (to the nearest 0.001 grams) into a 500 ml volumetric flask, according to the following table:

PRODUCT GRADE	TARGET WEIGHT
25% Solution	10 grams
31% Solution	8 grams
Solution 50	6.5 grams
Dry Flake	3 grams

3. Dilute to final volume of 500 ml and mix well.
4. Rinse a 0.5 ml Class A pipet with the above solution. Pipet 0.5 ml of the solution into a 100 ml Erlenmeyer flask containing 50 ml of

DI water, dilute to final volume of 100 ml. Mix well.

5. Prepare and inject a Milli-Q or equivalent water blank into the ion chromatograph.
6. Prepare and inject 5 ml of the diluted sample into the ion chromatograph and press the start button on the Nelson box.
7. Quantitation of sodium chlorate/sodium sulfate will be accomplished by comparison of sample peak heights to standard peak heights OR via the Nelson integrator data system which also uses peak height. If using the Nelson, use a "Nelson dilution factor" of 100,000 and a "Nelson sample weight" of Wt (from step 2 above) divided by specific gravity. For flake, use the weight from step 2 above for "Nelson sample weight."

Calculations

Peak Height Single Point Calibration:

$$\text{ppm NaClO}_2/\text{Na}_2\text{SO}_4 = \frac{\text{Sx Pk Ht} \times \text{Std Conc.} \times 100,000 \times \text{Sp Gr}}{\text{Std pk ht} \times \text{Sx wt}}$$

where:

- Sx Pk Ht = sample peak height,
- Std Conc = standard concentration (ppm),
- Sp Gr = specific gravity of sample,
- Std Pk Ht = standard peak height,
- Sx wt = actual sample weight in grams, and
- 100,000 = dilution factor.

Nelson Calibration Curve:

$$\text{ppm NaClO}_2/\text{Na}_2\text{SO}_4 = \frac{\text{Cal Conc} \times 100,000}{\text{Nelson Sx wt}}$$

where:

- Cal Conc = ppm NaClO₂ or Na₂SO₄ concentrations from calibration curve
- 100,000 = Nelson dilution factor,
- Nelson Sx wt = actual sample weight / specific gravity (for liquid samples), or
- Nelson Sx wt = actual sample weight (for flake samples).

Notes

1. Nitrate and other anions may elute at nearly the same time as chlorate. If the procedure is

adapted to other samples, some sort of screening will be necessary to assure that no interfering substances are present.

2. Sodium chlorite is a very strong oxidizing reagent and as such is incompatible with strong reducing agents, finely powdered metals, phosphorus and acids!
3. Keep solid sodium chlorite away from combustible materials, heat, sparks, and open flame!
4. Do not use hydroxide eluents or hydroxide to adjust the pH of any eluent higher than pH 11 to effect selectivity changes. Using eluents with pHs greater than 11 may cause irreversible damage to the IonPac AS9-SC/AG9-SC Columns.

Standard Preparation

1. Stock standard (500 mg/l NaClO_3 , 740 mg/l Na_2SO_4): On an analytical balance weigh 0.25 grams of dry sodium chlorate into a weighing boat. Then weigh 0.37 grams of dry sodium sulfate into a weighing boat. Transfer the salts to a 500 ml volumetric flask, rinse boats into flask, dilute to final volume of with Milli-Q DI water, and mix well. Store in a labeled plastic bottle.
2. Working standard: Into a 100 ml volumetric flask about 2/3 full of DI water, micropipette 100 μl of the stock standard. Dilute to final volume of and mix well. This standard contains 0.50 mg/l NaClO_3 and 0.74 mg/l Na_2SO_4 .

(1 ml of 50 mg/l Na_2SO_4 solution, dilute to final volume of 100 ml, gives 0.739 mg/l Na_2SO_4 , if solid Na_2SO_4 is not available.)

3. Analyze the working standard three times, calculate, and average the peak heights for both NaClO_3 and Na_2SO_4 . Store and save the averages in Nelson method.

FURTHER INFORMATION

More detailed information on OxyChem sodium chlorite or any specific applications is available on request through the OxyChem Technical Service Department.

Technical Service Department
OxyChem
Wichita, KS 67215
800-733-1165 Ext. 1

OxyChem_Tech_Service@oxy.com

Important: The information presented herein, while not guaranteed, was prepared by technical personnel and is true and accurate to the best of our current knowledge. **NO WARRANTY OF MERCHANTABILITY OR OF FITNESS FOR A PARTICULAR PURPOSE, OR WARRANTY OR GUARANTY OF ANY OTHER KIND, EXPRESS OR IMPLIED, IS MADE REGARDING PERFORMANCE, SAFETY, SUITABILITY, STABILITY, OR OTHERWISE.** This information is not intended to be all-inclusive as to the manner and conditions of use, handling, storage, disposal, and other factors that may involve other or additional legal, environmental, safety or performance considerations, and Occidental Chemical Corporation assumes no liability whatsoever for the use of or reliance upon this information. Appropriate handling and use of the product remains the responsibility of the customer. No suggestions for use are intended as, and nothing herein shall be construed as, a recommendation to infringe any existing patents or to violate any Federal, State, local or foreign laws.